

Article number: 20136410

Description: E+G Ball knob DIN 319-KT-20-M5-E

Measures

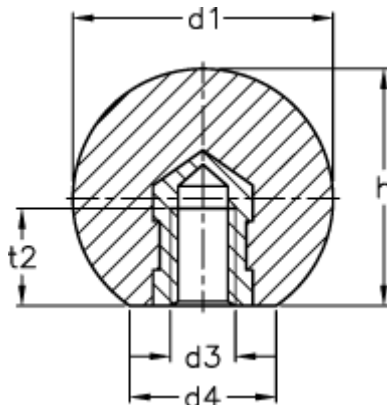

d1	= 20
d3	= M5
d4 approx.	= 12
h	= 18.0
t2 min.	= 7.5